

# Instrukcja montażu stołu

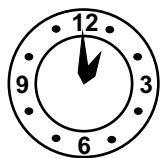

25 min.

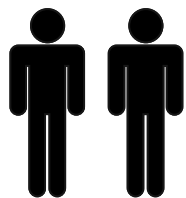
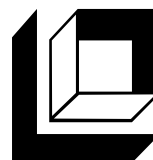

**KIELECKA  
FABRYKA  
MEBLI**

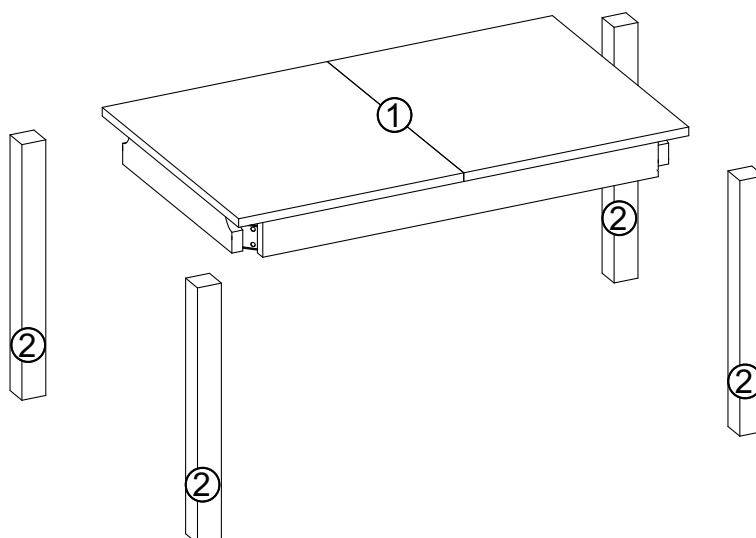

**Przed przystąpieniem do montażu należy sprawdzić zawartość paczek pod względem ilości i jakości z instrukcją montażu.**

**NIE WOLNO montować uszkodzonych elementów mebli, ewentualne ich wady należy zgłosić przed montażem w przeciwnym razie nie będą one podlegać reklamacji.**

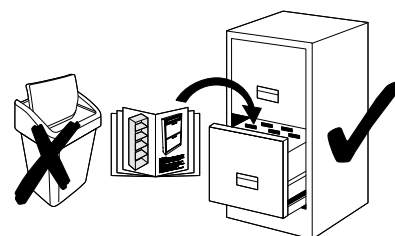

<b>(f3)</b>	x8	<b>(m)</b>	x1	<b>(r1)</b>	x8	<b>(r2)</b>	x8
				<b>M8</b>			



**Uwaga**  
Instrukcja montażu nie jest dokumentacją techniczną,  
producent zastrzega sobie możliwość zmian konstrukcyjnych.

**Pozor**

Montážní návod není technická dokumentace, výrobce si vyhrazuje právo na konstrukční změny.

**Pozor**

Montážny návod nie je technická dokumentácia, výrobca si vyhradzuje právo na konstrukčné zmeny.

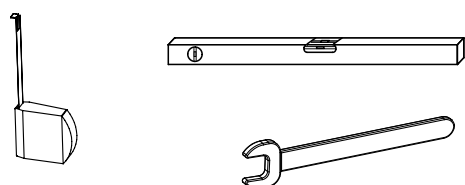

tel. 41 331 63 40,  
fax.41 331 64 11  
e-mail:biuro@k-f-m.pl  
<http://www.kieleckafabrykamebli.pl/>

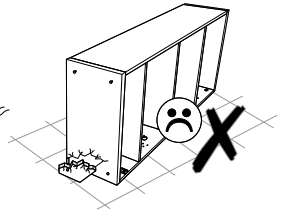
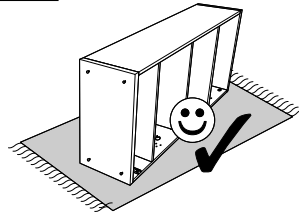
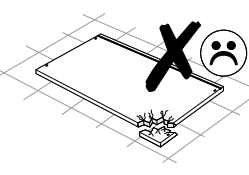
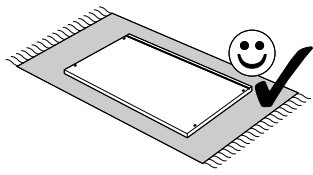

1

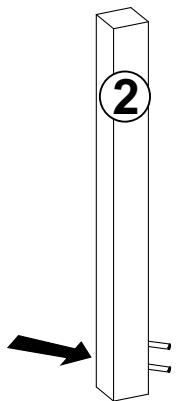
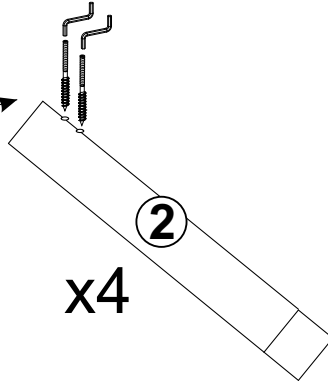
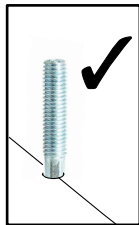
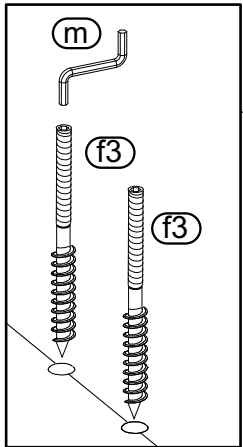

(r1) x2  
(r2) x2



(r1) x2  
(r2) x2

(r1) x2  
(r2) x2

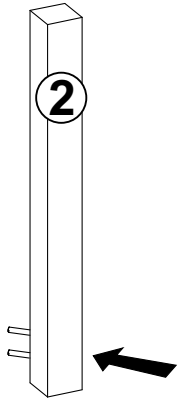
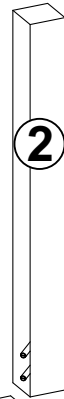

(r1) x2  
(r2) x2

