

INSTRUKCJA MONTAŻU - TERESA SZAFKA 2D

02

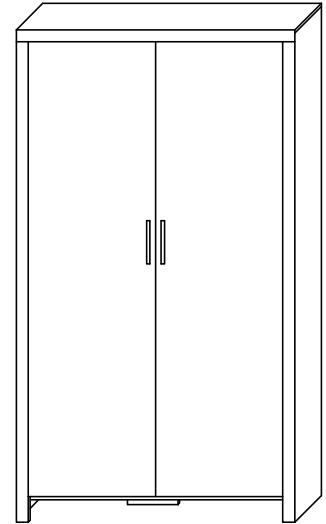

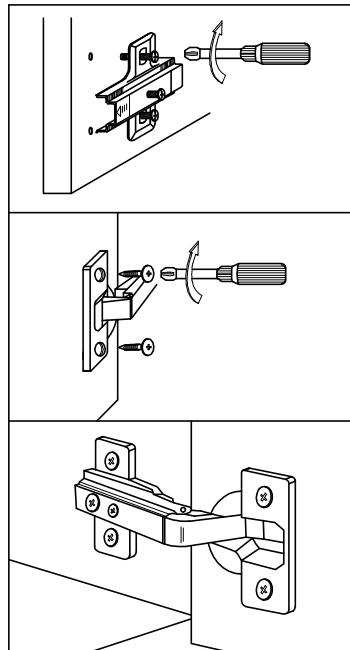

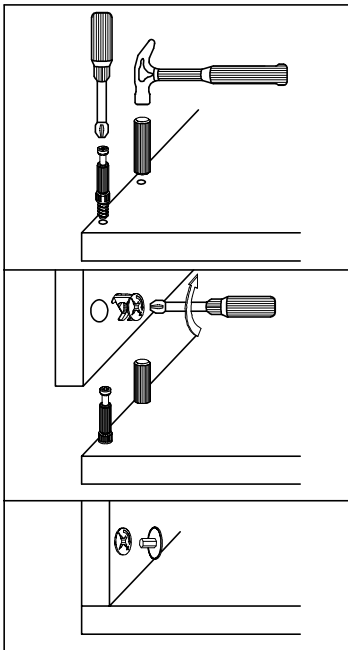



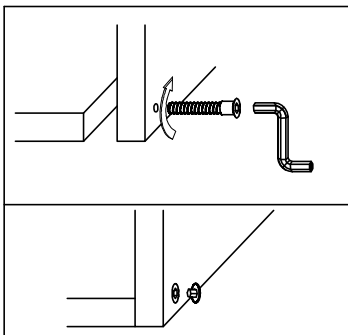



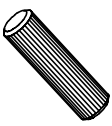

UWAGA! KLEJU UŻYWAĆ TYLKO DO MONTAŻU FRONTÓW SZUFLAD

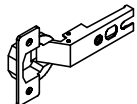

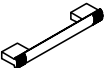
Przed przystąpieniem do montażu należy sprawdzić zawartość paczek pod względem ilości i jakości z instrukcją montażu.

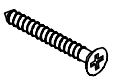
NIE WOLNO montować uszkodzonych elementów mebli, ewentualne ich wady należy zgłosić przed montażem w przeciwnym razie nie będą one podlegały reklamacji.



								
32	32	32	38	2	2	1	6	6
			3x13 	4x45 				
6	2	28	8	4	4	2	10	

2

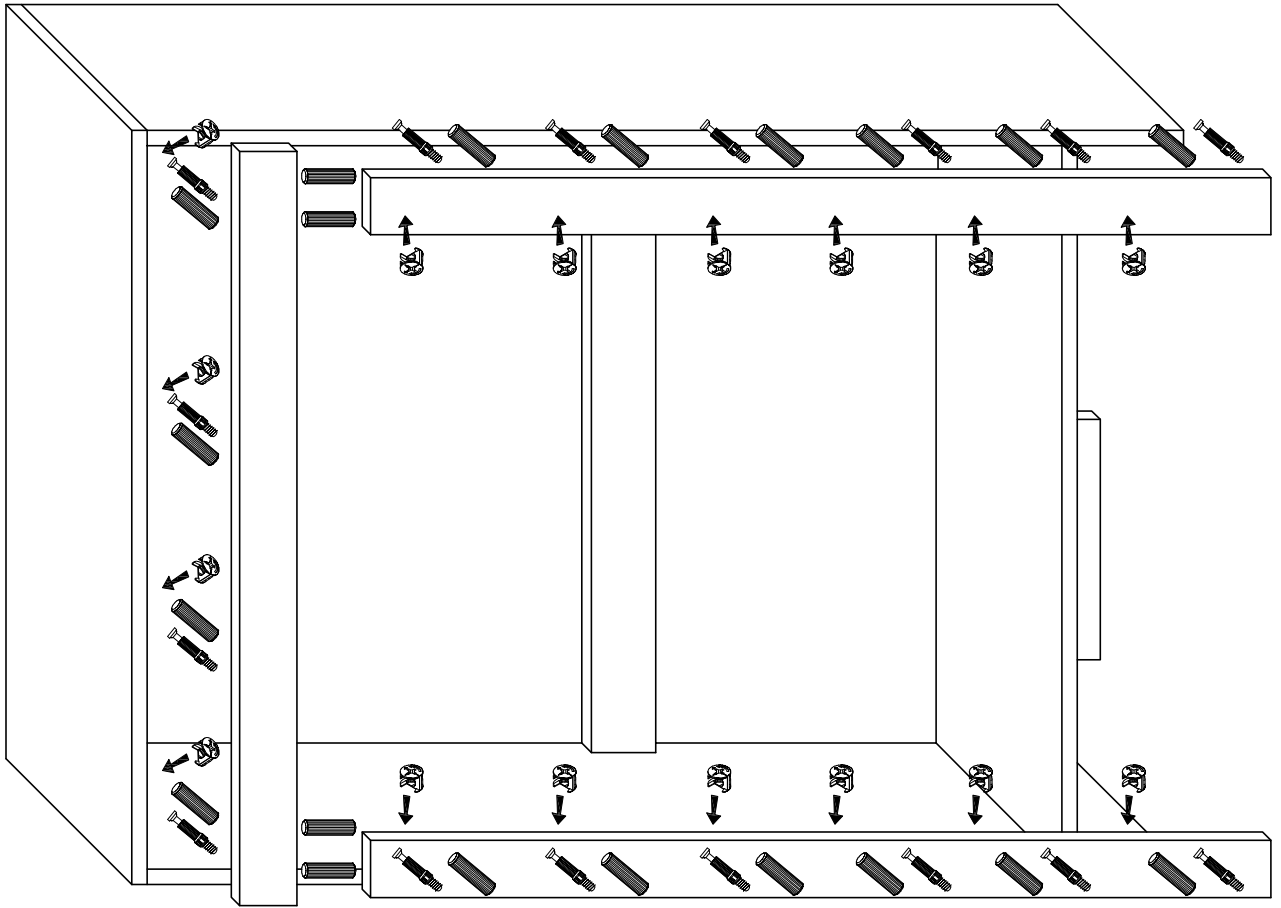

1

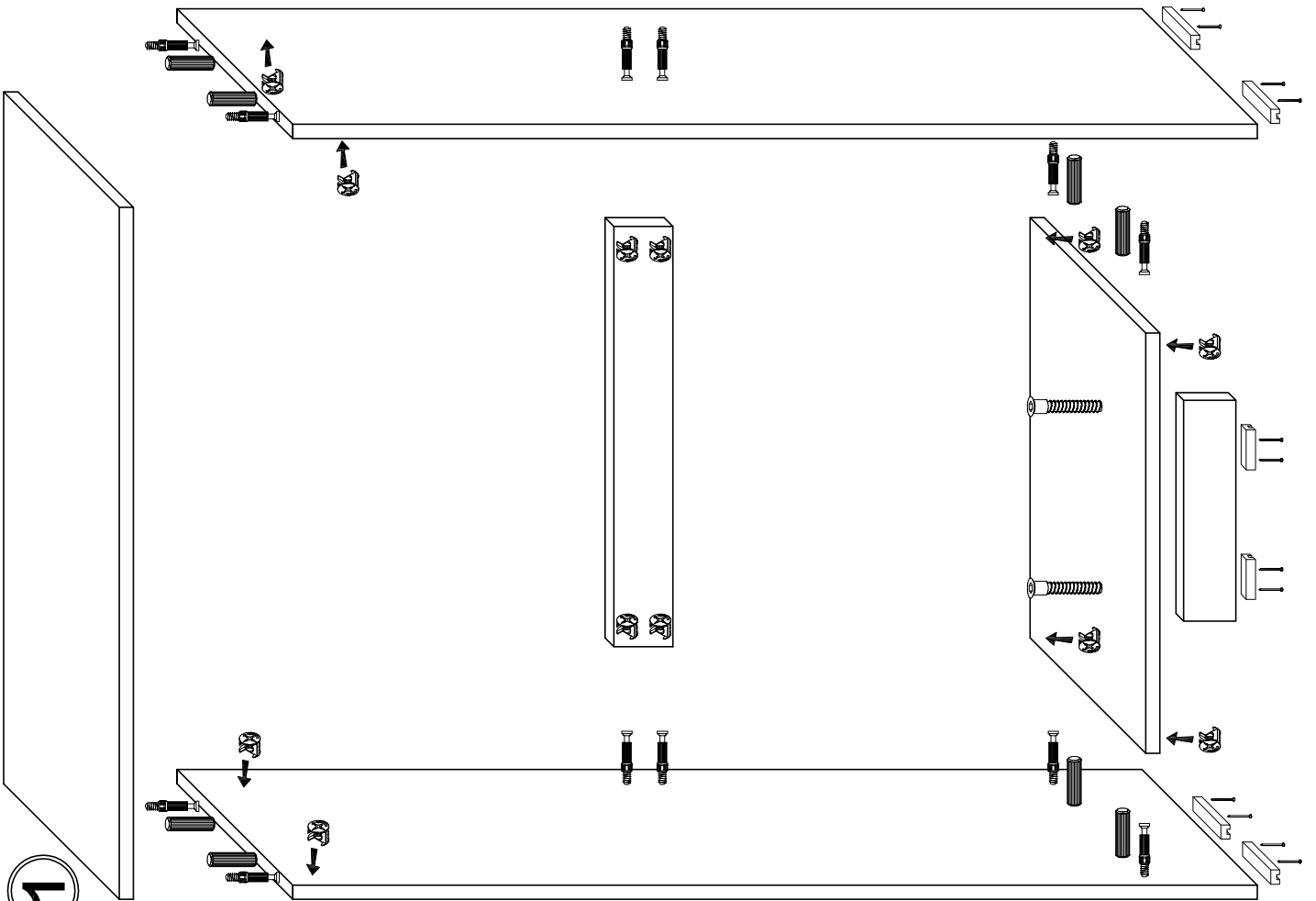

3

