

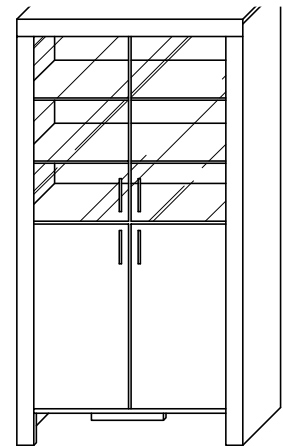

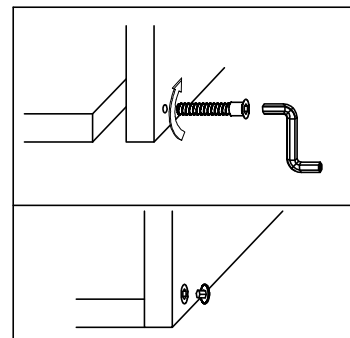

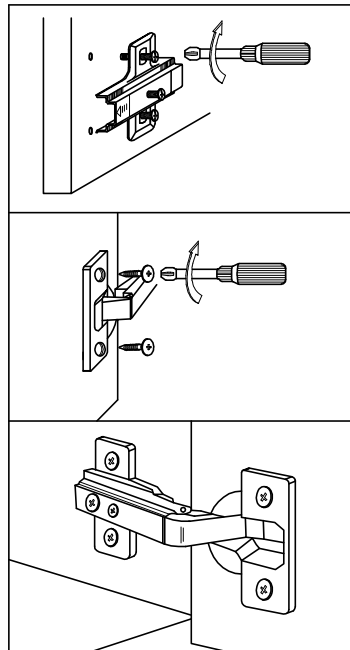

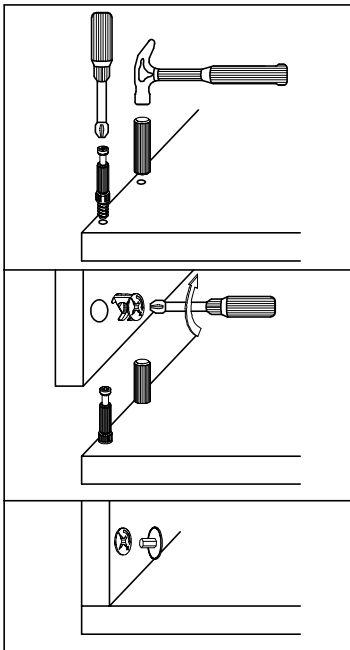







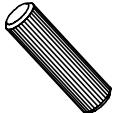

# INSTRUKCJA MONTAŻU - TERESA WITRYNA 2D2W

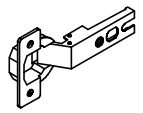
## 03

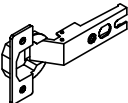
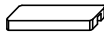
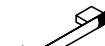

Przed przystąpieniem do montażu należy sprawdzić zawartość paczek pod względem ilości i jakości z instrukcją montażu.

**NIE WOLNO** montować uszkodzonych elementów mebli, ewentualne ich wady należy zgłosić przed montażem w przeciwnym razie nie będą one podlegać reklamacji.

								
28	28	28	32	2	2	1	4	8
					4x30 	4x45 		
4	6	4	28	8	4	4	14	8

1

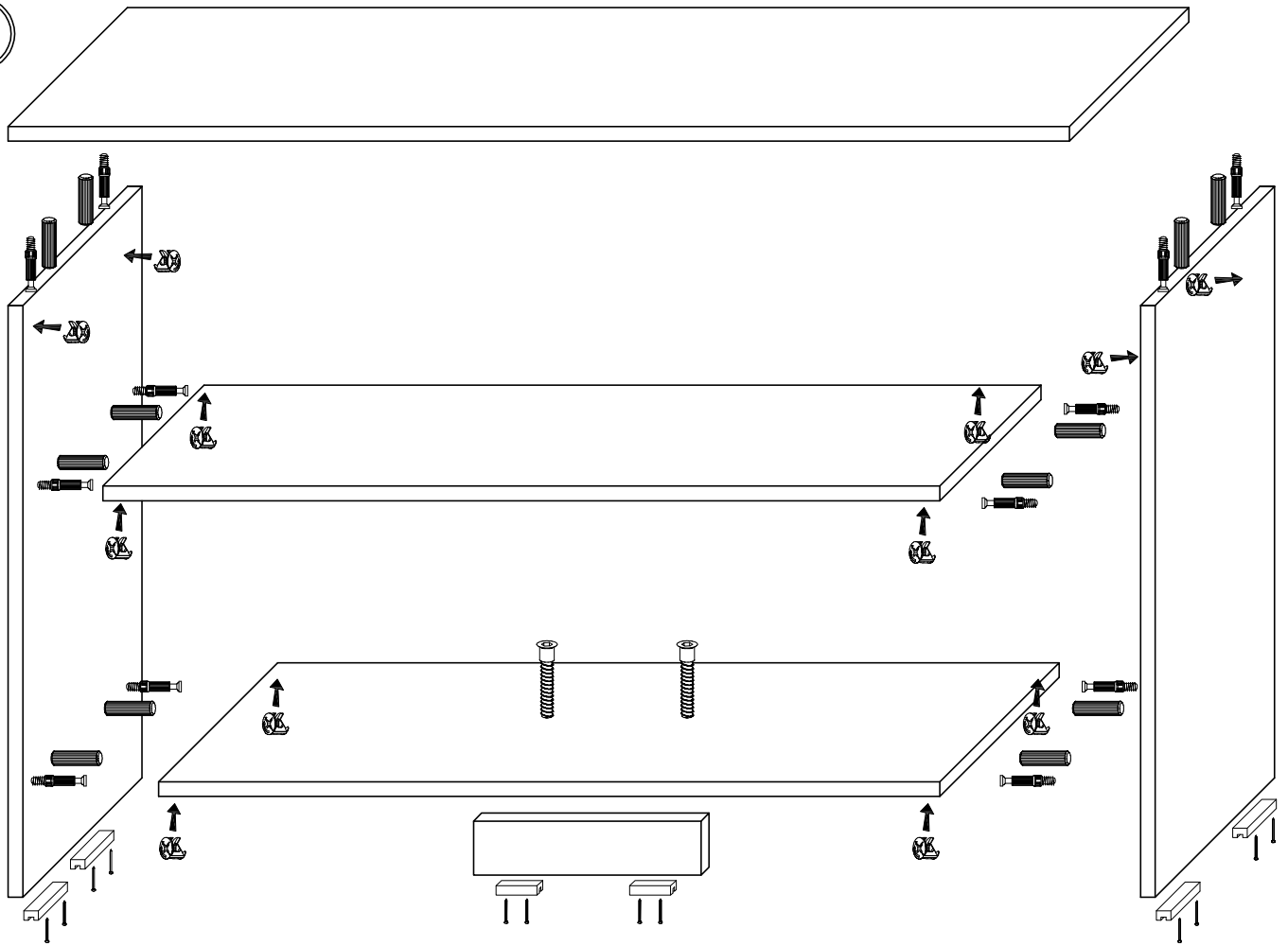

2

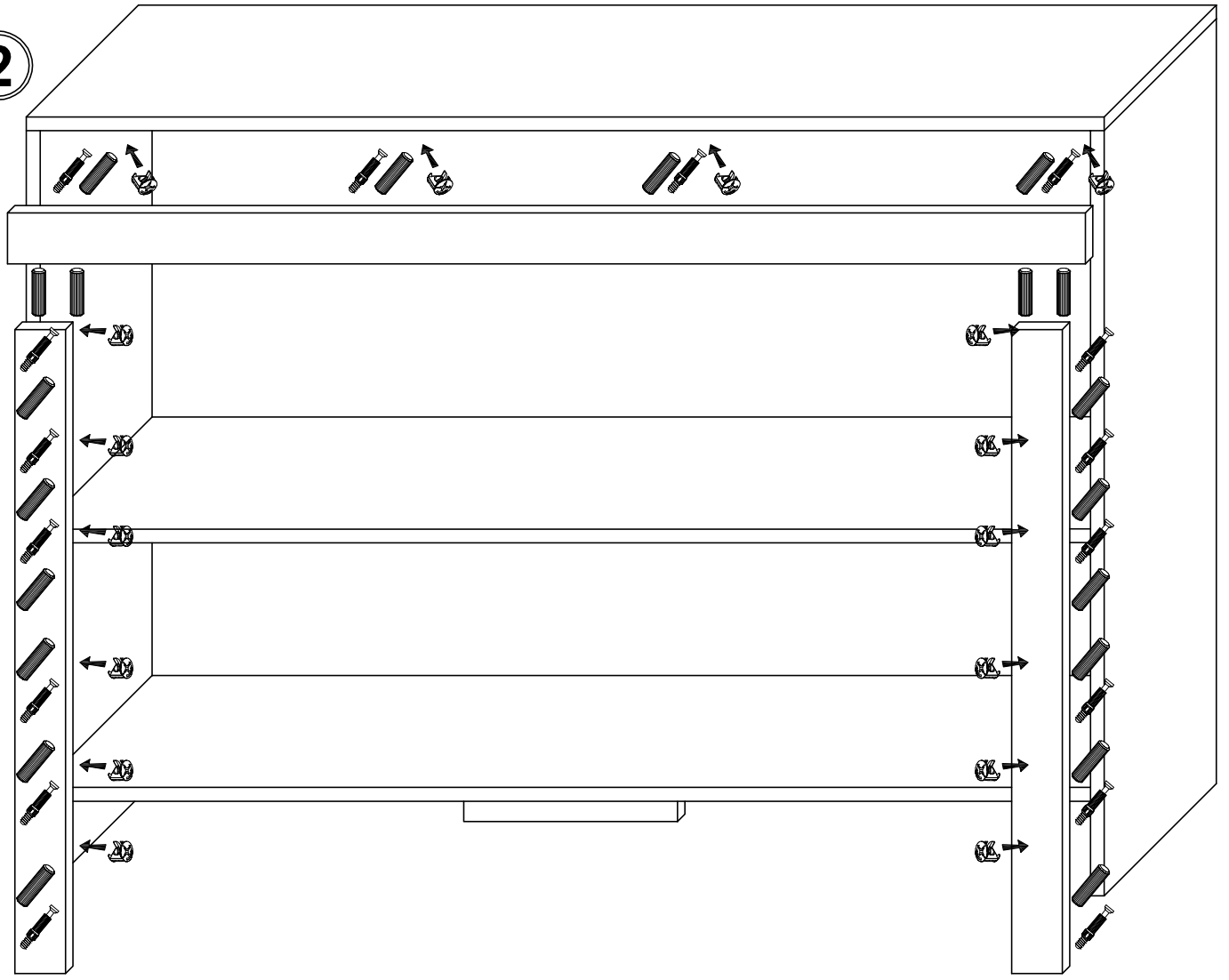

3

