

INSTRUKCJA MONTAŻU - TERESA KOMODA 1D3S

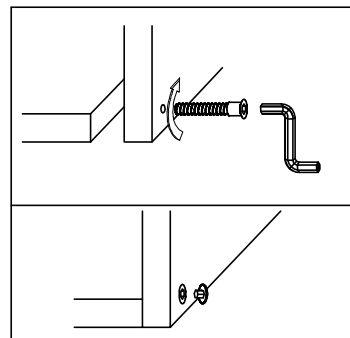

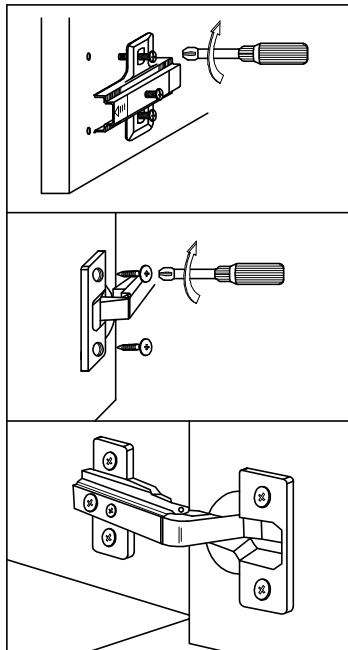

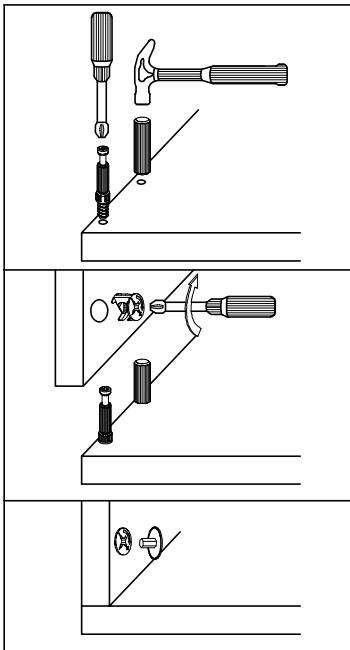

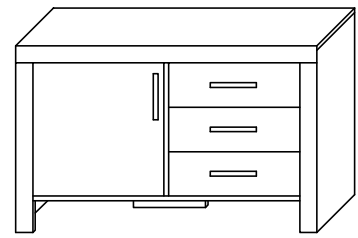





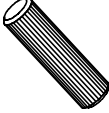

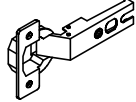

11

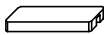
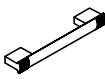
UWAGA! KLEJU UŻYWAĆ TYLKO DO MONTAŻU FRONTÓW SZUFLAD

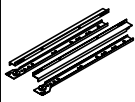
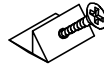

Przed przystąpieniem do montażu należy sprawdzić zawartość paczek pod względem ilości i jakości z instrukcją montażu.

NIE WOLNO montować uszkodzonych elementów mebli, ewentualne ich wady należy zgłosić przed montażem w przeciwnym razie nie będą one podlegać reklamacji.

								
26	26	26	30	2	2	1	2	2
								
12	6	4	20	2	4	3	8	
								
3,5x16	4x45							
4	4	4						

1

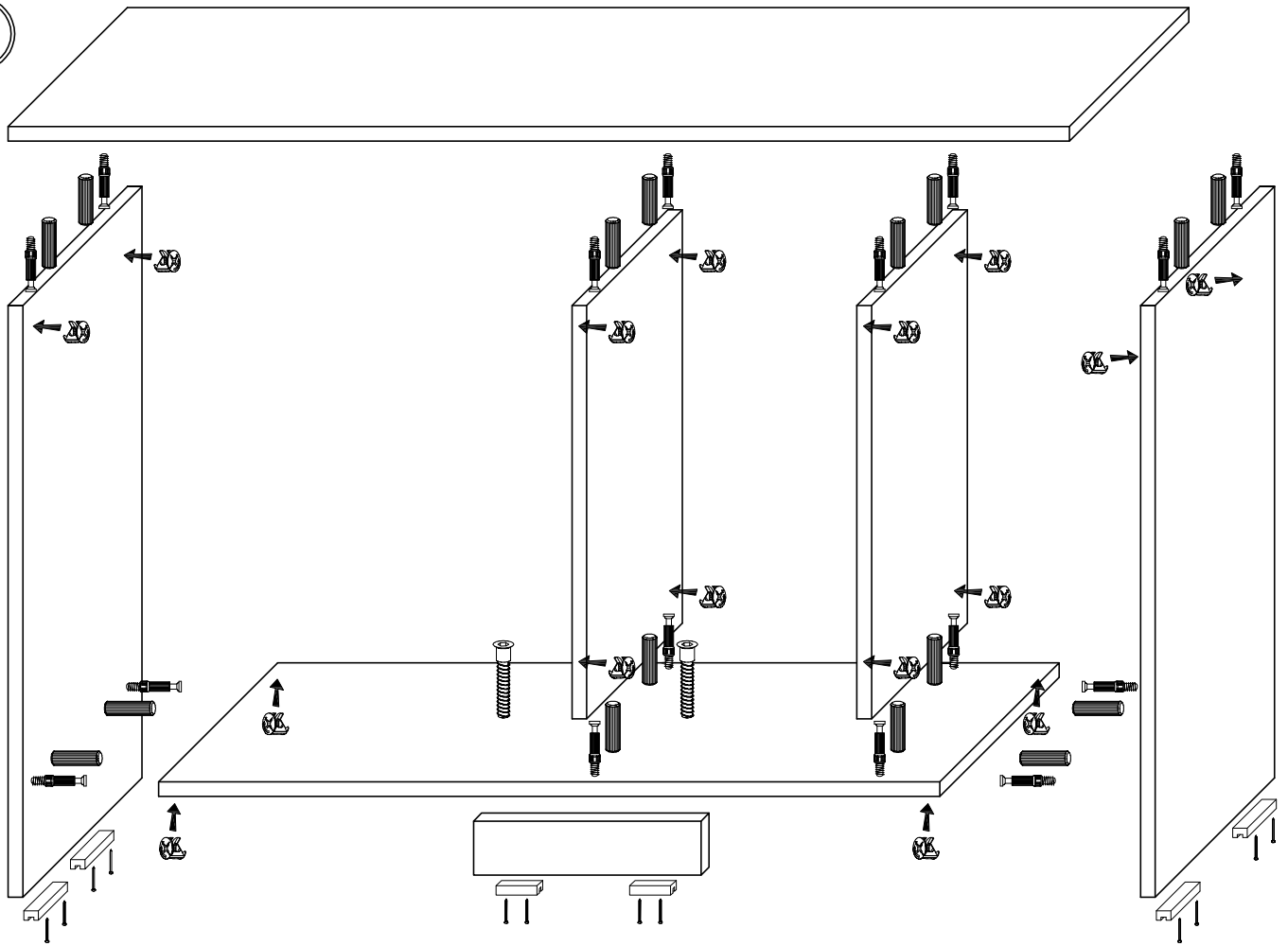

2

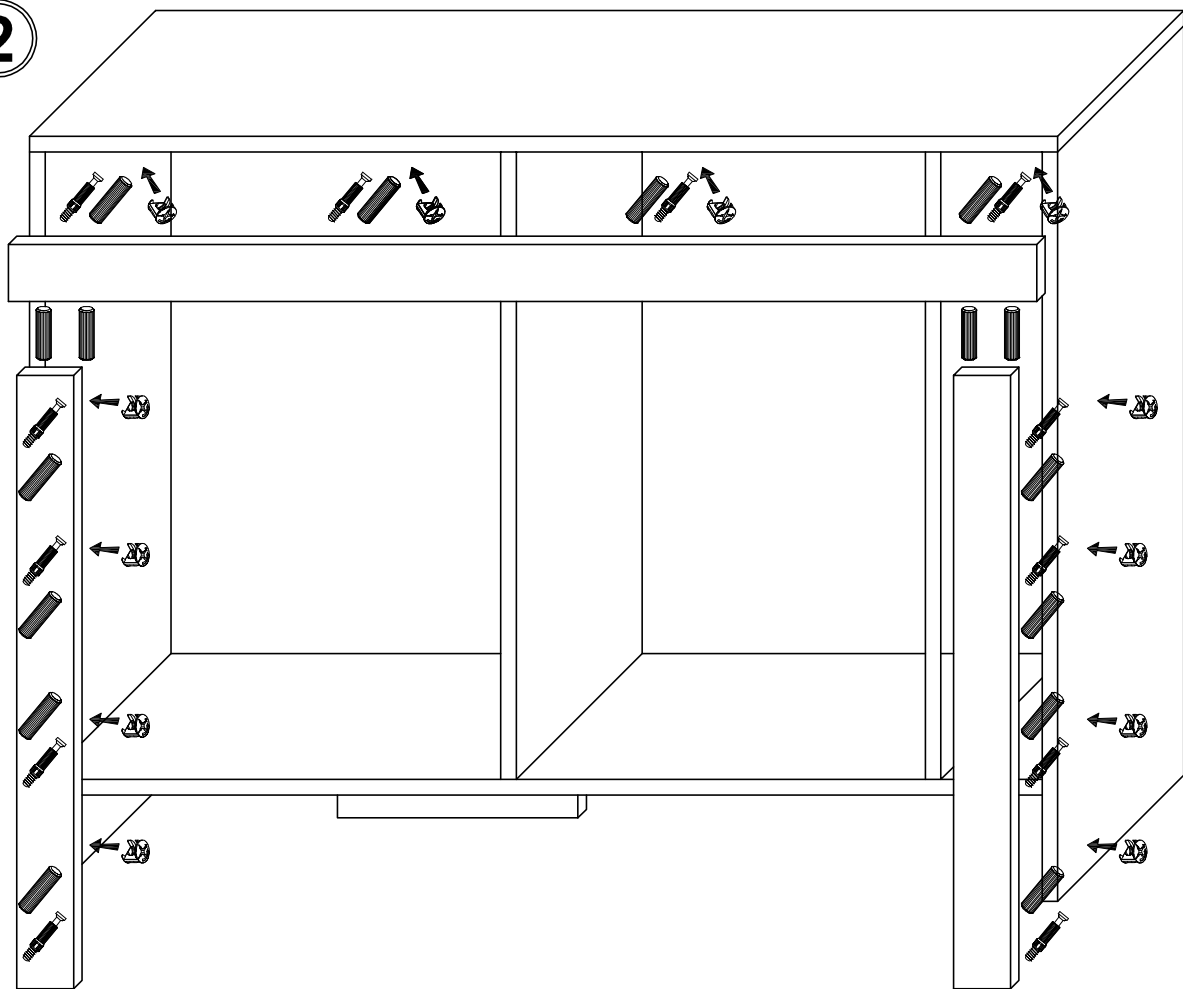

3

