

# INSTRUKCJA MONTAŻU - TERESA TOALETKA

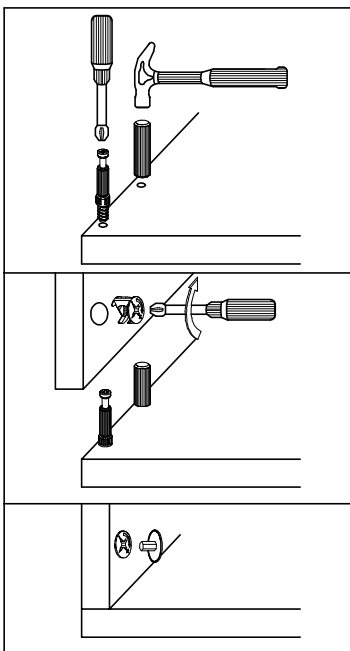

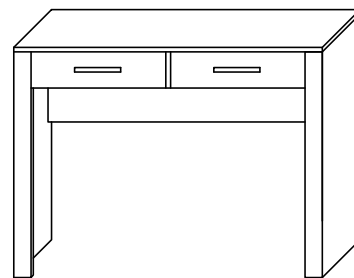





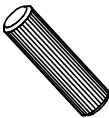

## 16

**UWAGA! KLEJU UŻYWAĆ TYLKO DO MONTAŻU FRONTÓW SZUFLAD**

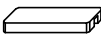
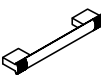

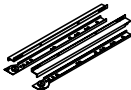
**Przed przystąpieniem do montażu należy sprawdzić zawartość paczek pod względem ilości i jakości z instrukcją montażu.**

**NIE WOLNO montować uszkodzonych elementów mebli, ewentualne ich wady należy zgłosić przed montażem w przeciwnym razie nie będą one podlegać reklamacji.**

|                                                                                    |                                                                                               |                                                                                             |                                                                                     |                                                                                     |                                                                                     |                                                                                       |                                                                                       |                                                                                       |
|------------------------------------------------------------------------------------|-----------------------------------------------------------------------------------------------|---------------------------------------------------------------------------------------------|-------------------------------------------------------------------------------------|-------------------------------------------------------------------------------------|-------------------------------------------------------------------------------------|---------------------------------------------------------------------------------------|---------------------------------------------------------------------------------------|---------------------------------------------------------------------------------------|
|  |            |          |  |  |  |  |  |  |
| 22                                                                                 | 22                                                                                            | 22                                                                                          | 22                                                                                  | 8                                                                                   | 4                                                                                   | 2                                                                                     | 8                                                                                     | 1                                                                                     |
|  | 3,5x16<br> | 4x30<br> |  |                                                                                     |                                                                                     |                                                                                       |                                                                                       |                                                                                       |
| 2                                                                                  | 8                                                                                             | 2                                                                                           | 2                                                                                   |                                                                                     |                                                                                     |                                                                                       |                                                                                       |                                                                                       |

1

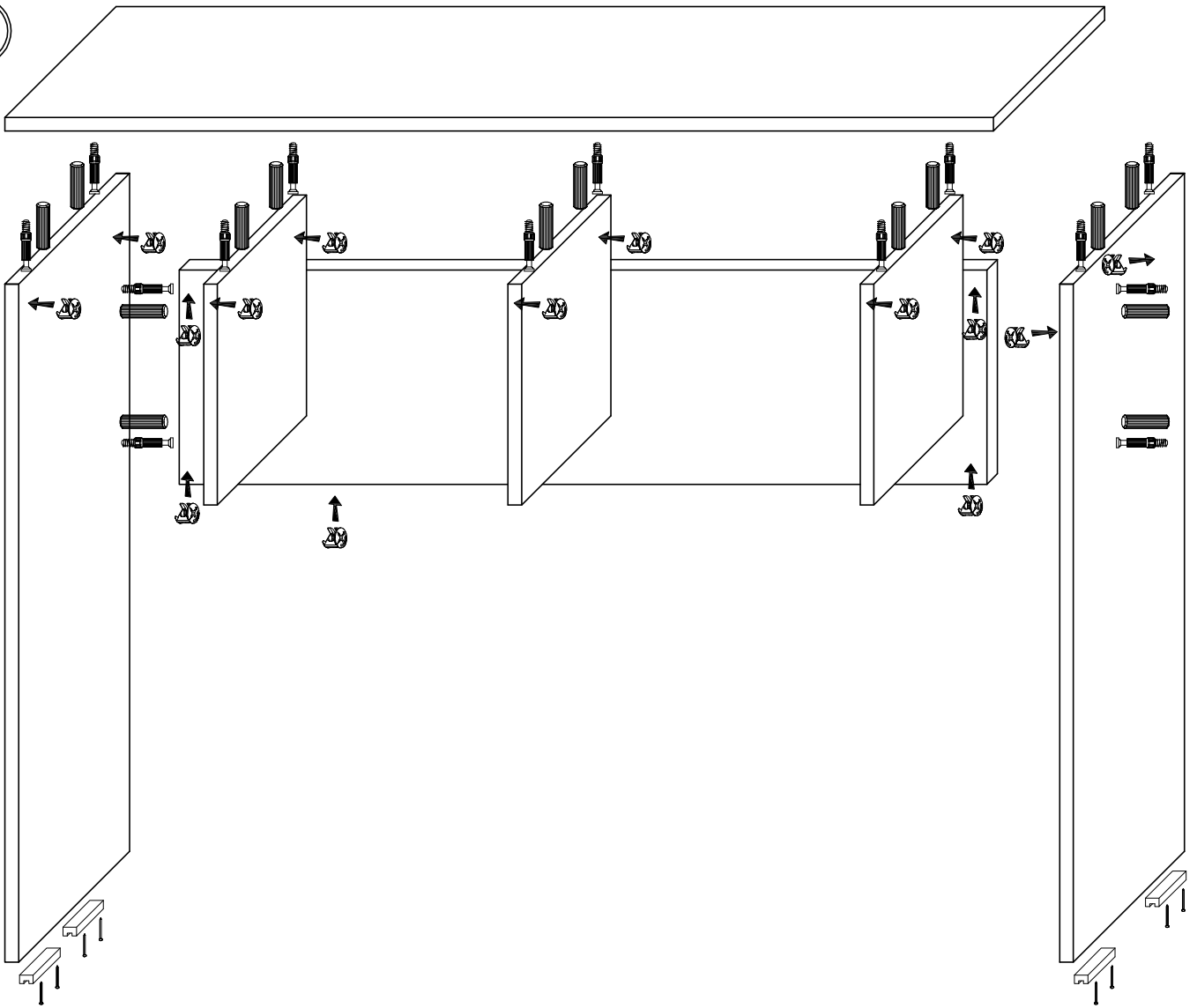

2

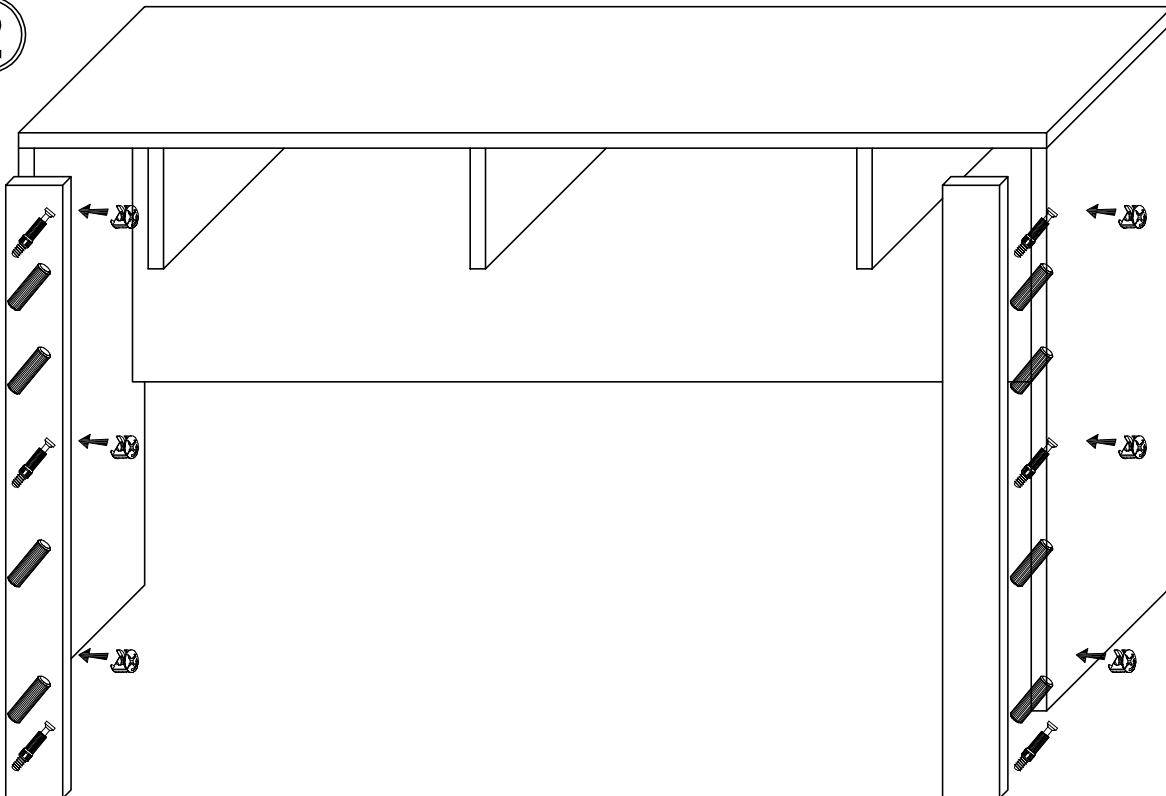

3

